

SSB RADIOTELEPHONE

# TRC-70

---

## INSTRUCTION MANUAL

KENWOOD CORPORATION

**KENWOOD**

Thank you for purchasing this new SSB radiotelephone .

**IMPORTANT:**

Please read this instruction manual carefully before placing your SSB radiotelephone in service.

SAVE THIS INSTRUCTION MANUAL

**INTRODUCTION**

Your SSB radiotelephone has been designed to provide dependable communications, and is simple and easy to operate.

ALL KENWOOD radios incorporate the latest in advanced technology, providing communications that can be counted on to keep vehicles and personal operating at peak efficiency.

**IMPORTANT:**

GOVERNMENT LAW PROHIBITS THE OPERATION OF UNLICENSED RADIO TRANSMITTERS WITHIN THE TERRITORIES UNDER GOVERNMENT CONTROL. ILLEGAL OPERATION IS PUNISHABLE BY FINE OR IMPRISONMENT OR BOTH.

REFER SERVICE TO A QUALIFIED LICENSED OR CERTIFIED TECHNICIAN ONLY.

**CONTENTS**

**OPERATION**

OPERATING CONTROLS. . . . .	4
RECEIVER OPERATION. . . . .	6
TRANSMITTER OPERATION. . . . .	6
MEMORY . . . . .	8
SCAN . . . . .	8

**MAINTENANCE** . . . . . 9

**INSTALLATION INSTRUCTIONS** . . . 11

**CHANNEL MEMO** . . . . . 12

**SAFETY**

It is important that the operator understands and is aware of hazards common to the operation of any SSB radiotelephone.

**WARNING:**

**1. EXPLOSIVE ATMOSPHERES (GASES, DUST, FUMES, etc.)**

Turn off and do not operate your SSB radiotelephone while taking on fuel, or while parked in gasoline service stations. Do not carry spare fuel containers in the trunk of your vehicle if your radio is mounted in the trunk area.

**2. INJURY FROM RADIO FREQUENCY TRANSMISSIONS**

Do not operate your SSB radiotelephone when anyone is touching the antenna, or when anyone is standing within two to three feet of your antenna, to avoid the possibility of radio frequency burns or related physical injury.

**3. DYNAMITE BLASTING CAPS**

Dynamite blasting caps may explode by the operation of SSB radiotelephone transmitters, if such operation occurs within 500 feet of the blasting caps. Turn off and do not operate your SSB radiotelephone when in an area where blasting is in progress, or where "TURN OFF TWO-WAY RADIO" signs have been posted. If you are transporting blasting caps in your vehicle, make certain they are carried in a closed metal box having a padded interior. Do not transmit during the time that caps are being placed into or removed from this container.

**UNPACKING AND CHECKING EQUIPMENT**

**NOTE:**

The following instructions are for use by your KENWOOD dealer; either an authorized KENWOOD service facility, or the factory only.

Carefully unpack the SSB radiotelephone. It is recommended that you identify the items listed and check them off before discarding the packing material. If any damage has occurred to the equipment during shipment, file a claim with the carrier immediately.

Microphone . . . . .	T91-0338-05 . . . . .	1 ea.
Microphone hanger . . . . .	J19-1376-15 . . . . .	1 ea.
Tapping screw . . . . .	N09-2106-05 . . . . .	3 ea.
DC cable . . . . .	E30-2194-05 . . . . .	1 ea.
External speaker plug . . . . .	E12-0001-15 . . . . .	1 ea.
Fuse (30A) . . . . .	F05-3034-05 . . . . .	1 ea.
Fuse ( 4A) . . . . .	F06-4027-05 . . . . .	1 ea.
Label . . . . .	B42-3382-04 . . . . .	1 ea.
Wing bolt . . . . .	N09-2080-05 . . . . .	1 ea.
Flat washer . . . . .	N15-1040-60 . . . . .	2 ea.
Instruction manual . . . . .	B50-8322-00 . . . . .	1 copy

# 1. OPERATION

## 1-1. OPERATING CONTROLS FRONT PANEL

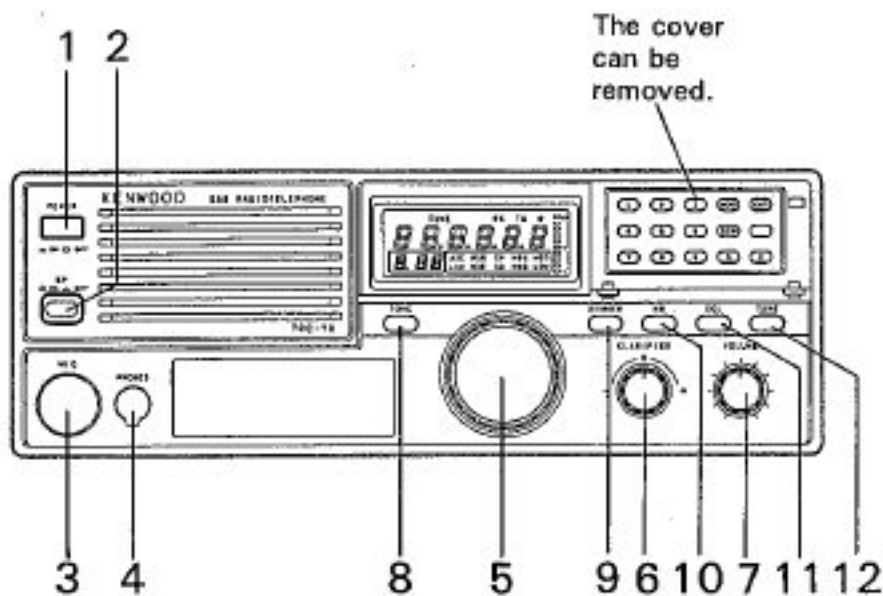

- 1 **POWER switch**  
This key is used to turn ON the SSB radiotelephone.
- 2 **SP( SPEAKER ) switch**  
This switch is used to turn the internal speaker on and off.  

NOTE; If the switch is in the off position, the internal speaker is disabled completely and no signal will be heard through the speaker . Check the position of the switch if no audio output is obtained from the speaker.
- 3 **MICROPHONE connector**  
Attach the supplied microphone to this connector.
- 4 **PHONE jack**  
Output terminal for headphones.
- 5 **Channel selector**  
This control is used to select a memory channel.
- 6 **CLARIFIER control**  
This control is used to clarify the receiving frequency when the incoming signal is slightly off frequency.  
Rotating the control shifts the receive frequency to either side of the displayed frequency in 10 Hz steps up to a maximum of  $\pm 500\text{Hz}$  .
- 7 **VOLUME control**  
Rotating the control clockwise will increase the volume.
- 8 **TONE key**  
This key is used to transmit a 1500Hz tone frequency to adjust a receive frequency.

- 9 **DIMMER key**  
This key is used to select the desired display intensity ( high , medium , low , or off ).
- 10 **NB key**  
This key selects the desired Noise blanker mode; 1, 2, or off .  
Noise blanker 1 For short duration pulse type noise, place the NB 1 switch ON.  
Noise blanker 2 For long duration pulse type noise, like the woodpecker, place the NB 2 switch ON.

NOTE; If you use NB 2 for short duration pulse noise, the receive audio may become distorted, making it difficult to understand.

- 11 **SQL key**  
This key is used to control the squelch circuit.
- 12 **TUNE key**  
This key is used to engage the automatic antenna tuner .

## FUNCTION KEYS

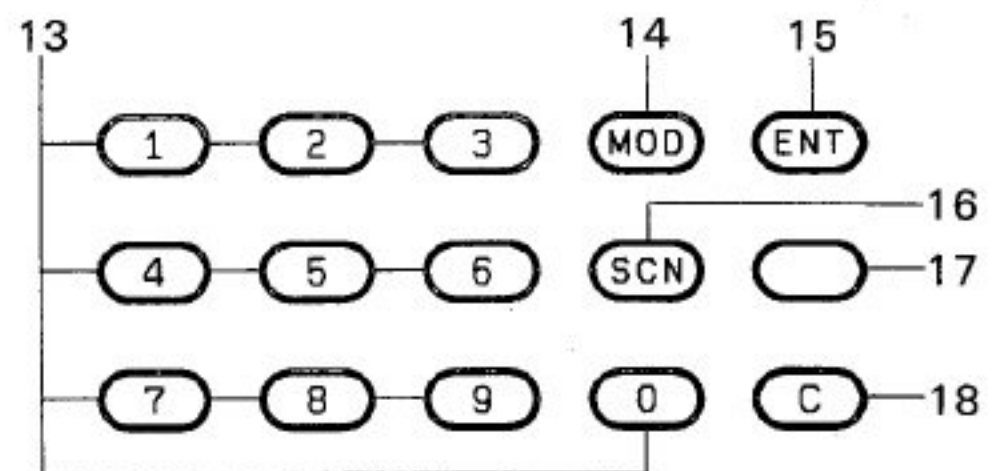

- 13 **Numeric keys**  
These keys are used for recalling a Memory channel.
- 14 **MODE key**  
This key is used to select USB(J3E), LSB(J3E), CW ( A1A ) or H3E(AM) mode.
- 15 **ENT key**  
This key is used to begin direct keyboard entry of the channel number into a memory channel .
- 16 **SCN(SCAN) key**  
This key is used to initiate scan.
- 17 **BLANK** Not used.

## 18 C key

This key is used to release SCAN, and to clear a memory channel selection when using the numeric keys.

After pressing the C key press the any of the following numeric keys and then ENT key to select the appropriate function.

- 80 Beep ON
- 81 Beep OFF
- 82 When automatic antenna coupler is equipped, pressing the PTT switch activate the antenna coupler automatically.
- 83 Antenna coupler is not activated by pressing the PTT switch.

- 6 Receive only indicator  
Displays the receive only channel.
- 7 *BB*  
Indicates the selected memory channel number that the displayed frequency is stored into.
- F - -*  
On during Function mode.
- 8 dot  
Flashes during scanning.
- 9 J3E / USB / LSB / CW / H3E  
Indicates the emission mode.
- 10 SQ  
On when the squelch mode is on.
- 11 NB1 / NB2  
Indicates the selected noise blanker mode.
- 12 Level meter  
Indicates the relative receive signal strength, or antenna current.

## DISPLAY PANEL

### MEMORY CHANNEL DISPLAY



### FREQUENCY DISPLAY

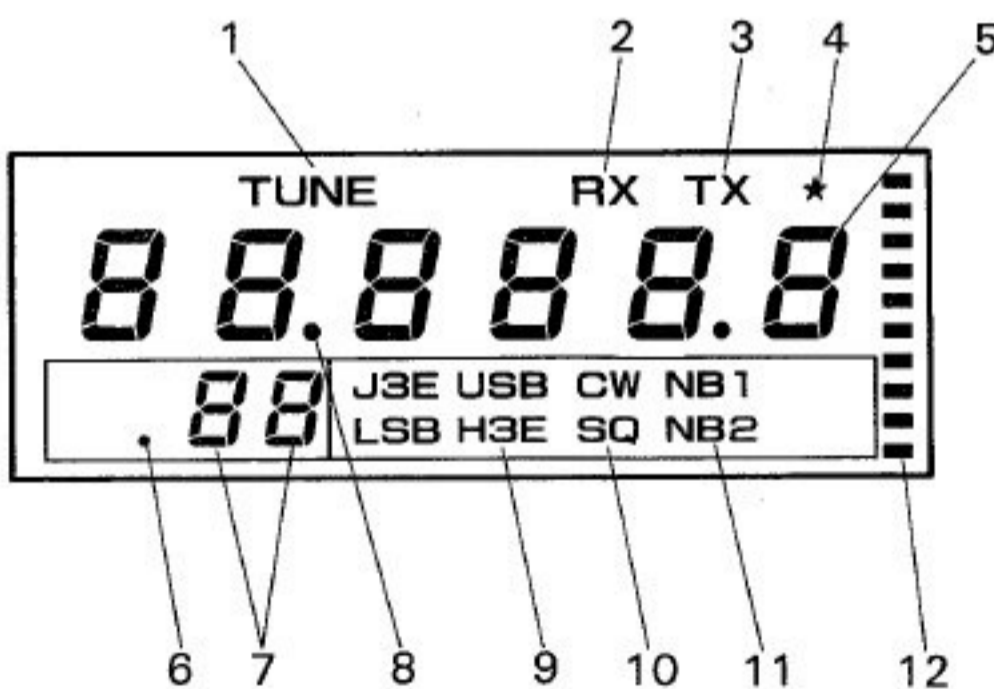

- 1 TUNE  
Flashes during tuning.  
On continuously when a good match is obtained.
- 2 RX  
On during receive.
- 3 TX  
On during transmit.
- 4 \*  
On when the clarifier is activate.
- 5 *BB.BB.BB.BB*  
Displays the operating channel number or frequency.

## REAR PANEL

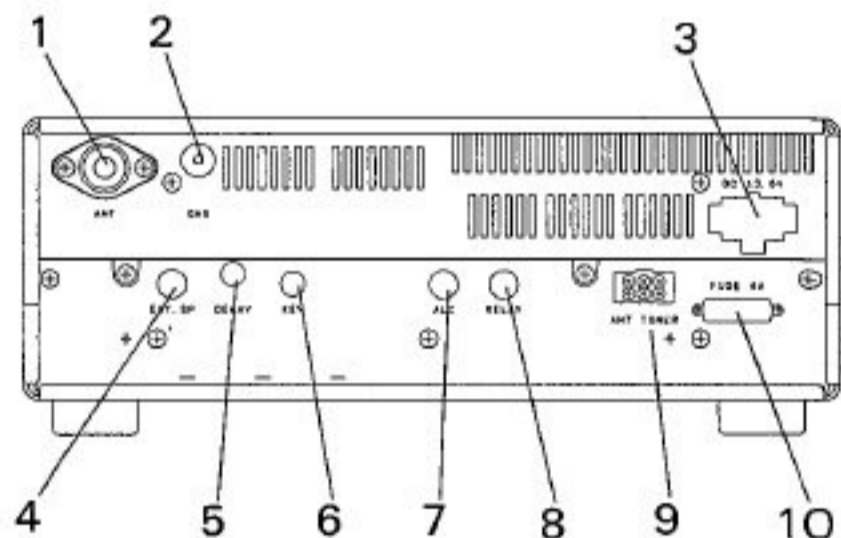

- 1 Antenna connector  
Attach an antenna with a low SWR and impedance of 50 Ohms.
- 2 GND terminal
- 3 13.6 VDC power input connector  
Connect the DC power cable to this connector.
- 4 External speaker jack  
Connect an external speaker to this connector. The speaker should have an impedance of 8 Ohms.
- 5 DELAY control  
This control adjusts the "hang-time" that the radio will remain keyed after voice input has stopped.
- 6 KEY jack  
Using shielded line, connect a 1/4" phone plug to this jack for CW operation. Open-terminal voltage is approximately 5.5 VDC.
- 7 ALC input  
Provides connection for a linear amplifier control.
- 8 RELAY terminal  
This terminal provides a ground on transmit. Relay contact capacity is 30 VDC / 0.5 A.
- 9 Antenna Tuner connector  
Connect the Antenna Tuner cable to this connector.
- 10 Fuse holder  
Contains a 4A fuse.

## 1-2. RECEIVER OPERATION

The SSB radiotelephone will supply audio confirmation whenever a function is activated.

1 short beep ; Key operation accepted.

1. Switch the radio ON.
2. Next, turn the CHANNEL selector to your regular operating channel. Normally, once you have selected this channel, it will not be changed.
3. Finally, make certain the SQL switch is selected.

### CHANNEL SELECTION

Rotate the Channel selector to recall the desired MEMO channel.

or DIRECT KEYBOARD ENTRY

Enter the MEMO channel number and then press the ENT key.

For example CH 11  
press ①, ①, and then ENT key.



Direct keyboard entry mode is released if you do not press the next key within 10 seconds of pressing the before key.

### RECEIVER OPERATION WITH OPTIONAL ANTENNA COUPLER

We recommend both the transmit and receive signal pass through the optional automatic antenna coupler to obtain at the maximum performance.

1. Select the desired operating channel.
2. Press the microphone PTT switch to initiate tuning.

TUNE indicator will flash during tuning and a continuous beep will sound from the radio.

NOTE; The receive only memory channel frequency can not be tuned.

In this frequency we recommend to tune nearby frequencies, or to turn the tuning function off by pressing the C/FUNC key and then the TUNE key.

3. When tuning is completed TUNE indicator will light.
4. Receive the channel.

The same frequency as once good matched need not to tune. To avoid interfering with other station do not tune unnecessarily.

## 1-3. TRANSMITTER OPERATION

The cooling fan operates automatically when long transmission or extended operation in HI power mode make the heat sink temperature to rises. The protection circuit in the unit will activate if the temperature rises over the limit, the output power will be automatically reduced to the LOW power.

In this case the LOW indicator does not light, the deflection of the ANTENNA current meter will decrease.

### Without optional ANTENNA COUPLER

#### NOTE

As delivered from the factory the antenna tuner is activated by pressing the PTT switch.

If you do not want the tuner to function at the beginning of each transmission press F, 8, 3, and then ENT. The automatic TUNE function will be disabled.

1. Select the desired operating channel.  
For example CH 11 : 2.5000MHz
2. Press the microphone PTT switch. The TX indicator will light.

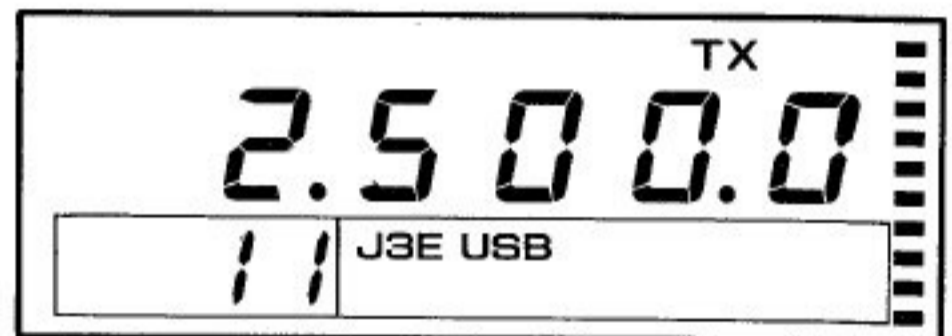

3. Speak into the microphone.  
The recommended distance to the microphone is 5 cm (2 inches).
4. Release the PTT switch to return to the receive mode. The TX indicator should go out.

### Equipped with optional ANTENNA COUPLER

#### CAUTION:

Always check to ensure the frequency is clear before transmitting.

There is a possibility of damaging the equipment if you transmit before TUNE indicator lights continuously.

● **AUTOMATIC ANTENNA TUNING**

1. Select the desired operating channel.  
For example CH 11 : 2.5000MHz



2. Press the microphone PTT switch.  
The TUNE indicator will flash during while it tunes and a continuous beep will be heard from the radiotelephone.

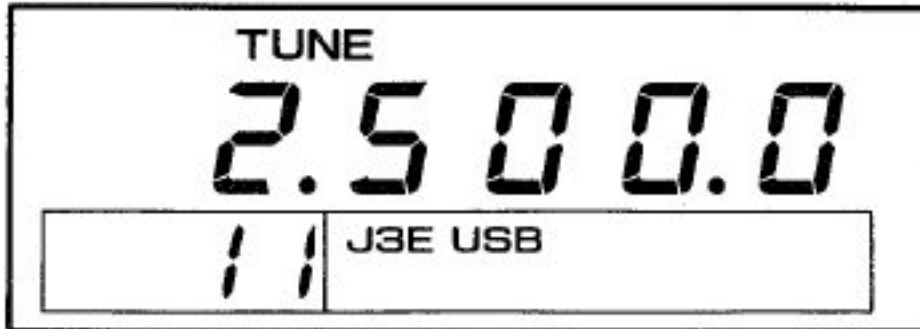

3. When tuning is completed the TUNE indicator will light continuously. The beep will stop. Press the microphone PTT switch. The TX indicator will light.



4. Speak into the microphone.  
The recommended distance to the microphone is 5 cm (2 inches).

**CAUTION ;**

Rotating the channel selector will cause the TUNE indicator to turn off, you must return before transmitting.

5. Release the PTT switch to return to the receive mode. The TX indicator should go out.

● **MANUAL ANTENNA TUNING**

1. Select the desired operating channel.  
For example CH 11 : 2.5000MHz



2. Press the TUNE key to activate the antenna coupler. The TUNE indicator will flash during tuning and a continuous beep will sound.



4. When tuning is completed the TUNE indicator will light continuously. Press the microphone PTT switch. The TX indicator will light.



5. Speak into the microphone.  
The recommended distance to the microphone is 5 cm (2 inches).

● **AUTOMATIC ANTENNA COUPLER FUNCTION CONTROL**

Press F, 8, 3, and then ENT to disable the automatic TUNE function.

Press F, 8, 2, and then ENT to enable the automatic TUNE function.

● **AUTOMATIC ANTENNA COUPLER OPERATION**

1. During tuning operation the TUNE indicator will flash and a continuous beep will sound.
2. When tuning is completed, TUNE indicator will light continuously.
3. When a good match has not been found within 15 seconds of the beginning of the tuner search, TUNE indicator will turn off.  
To stop tuning before a match is found press the TUNE key. This will disconnect the tuner.

## 1-4. MEMORY

### MICROPROCESSOR MEMORY BACKUP

An EEPROM is contained in this SSB radiotelephone to retain memory. Turning off the POWER switch, or a power failure will not erase the memory.

A lithium battery is installed to back up the display before turning off the POWER switch. The lithium battery should last for approximately five years. When the battery discharges, erratic information may appear in the display.

Lithium battery replacement should be performed by an authorized KENWOOD service facility; either your KENWOOD dealer.

### MICROPROCESSOR INITIALIZATION

To initialize ( reset ) the microprocessor use the following procedure.

To reset all user programmed data.

1. Turn the power switch off.
2. Press and hold the C/FUNC key and turn on the power switch.
3. Release the C/FUNC key.

## 1-5 SCAN

Scan is used to sample the band activity automatically.

### HOLD/ RESUME PROGRAMMING

One of the following scan hold/resume methods have been provided in MEMORY CHANNEL SCAN.

#### TIME OPERATED SCAN

When squelch turns off, the radio stops on a channel and remains there approximately 5 seconds, and then continues to scan even if the signal is still present.

#### VOICE OPERATED SCAN

When squelch turns on, the radio will stop scanning on a busy channel and remain there until the signal drops out. The radio allows a 5 second delay before it resumes scanning so that you don't lose the station when operators change.

## MEMORY CHANNEL SCAN

1. Rotate the channel selector to select the scan starting channel.
2. Press the SCN key to initiate scan. The MHz and/or kHz indicator will flash as a visual reminder that the SSB radiotelephone is scanning.

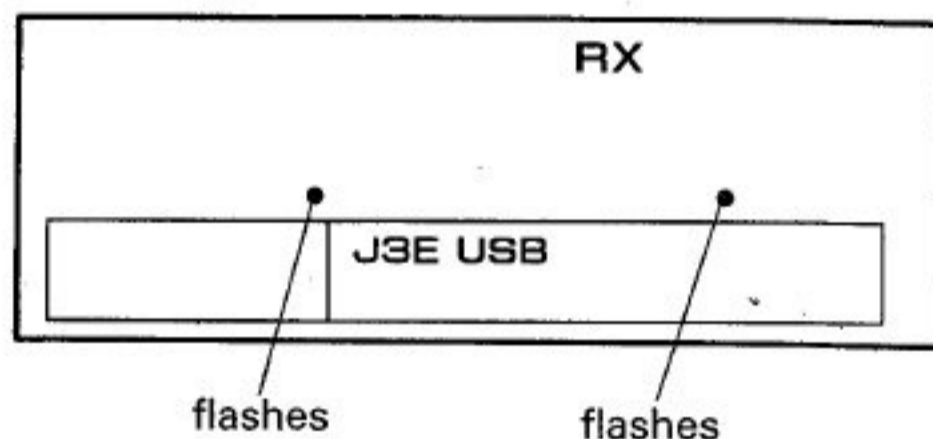
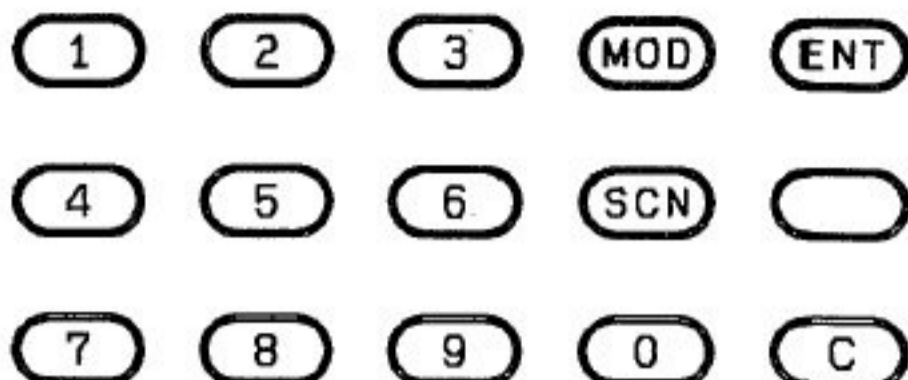

NOTE; No scanning will be performed if less than 2 memory channels have data.

3. Scan will begin in an upwards direction. You can reverse the direction of scan by turning the Channel selector counterclockwise.
4. (If VOICE OPERATED SCAN had been selected) Scan will stop whenever a signal is received that will open the squelch of the radio.
5. Press the C/FUNC key or the PTT switch ( no transmit will occur ) to clear scanning.

## **4. MAINTENANCE SERVICE**

Your SSB radiotelephone has been factory aligned and tested to specification before shipment. Under normal circumstances the SSB radiotelephone will operate in accordance with these instruction manuals. All adjustable trimmers and coils in your SSB radiotelephone has been adjusted at the factory and should only be readjusted by a qualified technician with proper test equipment. Attempting service or alignment without factory authorization can void the SSB radiotelephone 's warranty.

When operated properly, the SSB radiotelephone will provide many years of service without requiring realignment. The information in this section gives some general service procedures which can be accomplished without sophisticated test equipment.

Should it ever become necessary to return the equipment to your dealer or service center for repair, pack it in its original box and packing, and include a full description of the problems involved. Also include your telephone number. You need not return accessory items unless directly related to the service problem.

### **Service note :**

If you desire to correspond on a technical or operational problem, please make your note short, complete, and to the point, and PLEASE make it readable .

Please list: Model and Serial Number

The problem you are having.

Please give sufficient detail to diagnose. Information such as other equipment in the station, meter readings and anything else you feel might be useful in attempting diagnosis .

### **Caution :**

Do not pack the equipment in crushed newspapers for shipment. Extensive damage may result during shipment.

### **Notes :**

1. Record the Date of Purchase, Serial Number and Dealer from whom purchased.
2. For your own information, retain a written record of any maintenance performed on the unit.
3. When claiming warranty service, a photocopy of the bill of sale, or other proof of purchase showing the date of sale must accompany the radio.